

# CENTRA<sup>®</sup>

Centralized laboratory water systems



# CENTRA



“Water is  
all we do.  
We know  
water.”

We recognize that a fundamental element in designing or upgrading a laboratory is planning space and equipment needs for critical services, such as gases and high-purity water.

At ELGA, we have applied our expertise gained from 50 years of innovation in water purification technologies, to design CENTRA, a complete water purification, storage and distribution system packaged into a single unit. The CENTRA design overcomes the limitations of traditional central water purification systems to deliver consistent water purity, flexibility and economy.

This brochure outlines the key features of all the products in our CENTRA range that are designed to supply Type I to Type III purified water to everything from glassware washers and autoclaves to high purity polishers such as our PURELAB Ultra and PURELAB flex.

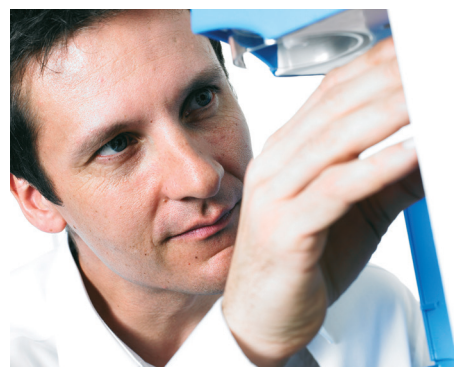

## Total confidence in your Pure Water system.

The CENTRA product family includes a Centralized Recirculating Distribution System and Centralized Purification and Distribution Systems (first purifies and then distributes the purified water).

All built in purification technologies are controlled by a central processor with audio-visual alarm warnings, an internal leak detection alarm and connection to building management systems.

Prior to installation a dedicated team of ELGA project engineers will work with you to develop a designed engineered solution and for complete peace of mind, every ELGA product is backed by a global service structure, ensuring your system remains cost-effective and delivers pure water during its entire life time.



# Centralized distribution of pure laboratory water

## adapting to your applications as they change

### The CENTRA Advantage

#### Purity

This is ensured by vent filtered wrap-around reservoirs, controlled distribution flow rates, and a selected range of purification technologies such as UV photo oxidation, deionization cartridges etc. Simple and easy sanitization processes ensure long-term bacterial control. A choice of purification media solutions is available to optimize inorganic and organic purity.

#### Flexibility

Modular design allows a number of CENTRAs to be connected, thereby creating a network of water units for a facility. Purity of water can be adapted to specific laboratory applications and changed as needs develop. A smaller footprint ensures the water purification system occupies less premium plant or laboratory space than conventional installations.

#### Economy

Individual laboratory needs can be met separately without requiring the entire building or site to have a higher specification.

Maintenance is easier on a smaller system and can be tailored towards the needs of individual laboratories.

Faster commissioning and installation time speeds up the build process and helps reduce costs.

The table below provides a summary of the CENTRA range and the key features of each product to help you match the best system to your laboratory design.

	CENTRALIZED DISTRIBUTION SYSTEMS		CENTRALIZED PURIFICATION AND DISTRIBUTION SYSTEMS	
Standard CENTRA Model	RDS	R 200	R 60/120	
Typical Flow rate	Up to 18 liters/min		Up to 10 liters/min	
High Flow CENTRA Model	RDS-HFV	R 200-HFV	n/a	
Typical Flow rate	Variable speeds up to a maximum of 30 liters/min <sup>1</sup>		n/a	
Reservoir Capacity	350 liters	350 liters	50 liters	
Recirculation Pump	√	√	√	
Reverse Osmosis		√	√	
UV Photo-oxidation	√	√	√	
0.2 µm Filter	√	√	√	
Optional Deionization	√	√	√	
Optional Composite Vent Filter	√	√	√	
System Monitoring/Safety Features	√	√	√	
Semi-automated Sanitization of Loop	√	√	√	

<sup>1</sup>Subject to the distribution loop design



# Worldwide service and support

---

## For total confidence in your pure water systems

Every CENTRA comes complete with one extra feature – first class service and support wherever you are in the world. ELGA has installed thousands of systems globally, and our service engineers will apply their expertise to the installation, validation and maintenance of your water purification systems in compliance with all the relevant codes.

Visit [www.elgalabwater.com](http://www.elgalabwater.com) to find your nearest contact.

### Service excellence

- We aim to provide first-time-fix service
- Preventative maintenance contracts are structured to match your precise needs, thereby minimizing interruptions to your workflow and sustaining system reliability
- All our calibration equipment is maintained to traceable standards and operated by fully trained service technicians ensuring your water quality is consistently maintained at the required standard

### Training

- “Hands on” operation training is arranged on or off site to ensure optimal system performance and minimize the risk of an interrupted workflow

### Technical assistance

- Our specialized local team will ensure you find the perfect product to match both your budget and applications
- Our dedicated local help desk is always available to provide advice, troubleshooting and parts identification



### Quality assured

Our commitment to the highest quality control processes guarantees reliability and compliance with both international, environmental and user organization standards.

Designed and manufactured under an ISO 9001:2000 total quality system. Tested to comply with CE, EMC, EN 61010 (UL CSA), PIRA, WEEE Directive and other standards as appropriate.

### Validation support

Water systems that are employed within a validated laboratory should operate within specification all of the time. This should be evidenced through documentation and trending should warn the user if performance is likely to fall below their requirements. ELGA offers a market-leading validation package with fully trained personnel using controlled equipment and documentation to support you throughout the validation process.

Online assistance at  
[www.elgalabwater.com](http://www.elgalabwater.com)

- Locate your local service representative
- Learn more about water quality and standards by downloading a FREE Pure Labwater Guide
- Find a water purification system which meets your needs with our online product selector





### Training and education in system design considerations

At ELGA we see it as our responsibility to ensure that clients, architects, consultants and contractors are made aware of the complexities when designing new lab services. We hold a range of training courses and seminars that cover detailed loop and system design through to basic awareness of key design issues. For more information contact [info@elgalabwater.com](mailto:info@elgalabwater.com).

## Facility design, build and installation – working together for a customized solution

---

We understand the challenges of designing, building and equipping research laboratories, whether you require a complete water purification package for an individual laboratory, a suite of laboratories, or all the laboratories and associated facilities (i.e. washing rooms) in a building.

We have provided centralized solutions that have met all specified lab water requirements economically and on budget across a broad range of organizations, including academic research laboratories in universities and institutes, clinical laboratories in hospitals, R&D laboratories in small biotechnology companies and laboratories in major pharmaceutical and biopharmaceutical corporations.



“Being part of Veolia Water, the world’s largest water purification company, gives us the capabilities and resources to provide unsurpassed centralized water purification solutions to either single or entire suites of laboratories in a building, immaterial of the quantities and qualities of purified water and the space available.”

Our ELGA team works together with architects, consultants, facilities managers, suppliers and scientists to provide help and expertise at all stages from conceptualizing and finalizing the facility design through to the actual build and water purification installation. The design and installation of complete water purification packages depends on a wide range of parameters that include:

- The specific scientific or clinical applications
- Feedwater quality
- Required range of water qualities and compliancy
- Range of water quantities i.e. peak-usage and normal usage per day or week
- Space availability
- Budget

## Your first step to Pure Water: The ELGA LabWater water analysis kit

### An informed start for a streamlined solution

At ELGA we do not speculate or work on assumptions about your water quality. On our first visit to your laboratory we will carry out a test, on site, that analyzes your feed water quality.

Armed with data about your laboratory's water quality, required applications, lab design and budget, our sales team will deliver an informed proposal about the best water purification solutions to suit your needs.

At ELGA we help you through the entire process of concept, design and implementation of your project. At the very early stages of planning, estimates can be provided for different scenarios without much information from the client. However, as the project progresses we will take you through a 'water usage assessment'. This identifies each point-of-use (e.g. sinks, washers and any local ultrapure systems) as well as the flow rate and volume required for a given period. It is important to identify peak and normal usage per hour, day and week, as well as pressure requirements. This information, combined with distribution loop length and path, will determine not only the overall amount of purified water, but also the most efficient size and type of system (purification, storage and distribution).

Using this data, our teams of contract engineers and project specialists will design the most efficient system for your design, using CENTRA modules as well as (if required) other ELGA products or bespoke components.

After installation and commissioning, our ongoing tailored service and maintenance support will ensure that your systems are running optimally.





# The CENTRA concept

## The centralized water system challenge facing modern laboratories

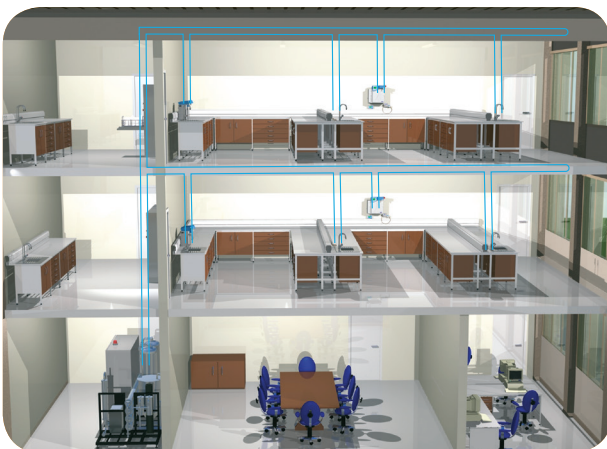

**Figure 1: A traditional central system.**

The single centralized system serves labs located on two floors, and takes up a large area in a dedicated plant room. Any usage changes in the labs will require the entire building to be up- or downgraded.

There is an increasing requirement for high purity water to support a wide range of research applications. Many research laboratories change their activities with time or need to scale up their current research applications, thereby requiring larger quantities of research-grade water. Laboratory reconfigurations will also change the demands on lab water. This continual need for adaptation to meet changing requirements has led to a more modular approach to laboratory design and architecture.

Traditionally, laboratory networks within a building can require larger central systems with very high storage volumes of pure water and powerful (high pressure) distribution systems. This type of design does not always optimize water purity and can lead to spiralling distribution costs (see Figure 1).





### Providing all the support you need

Our application specialists will provide advice and guidance on the most efficient and effective CENTRA solution for your laboratory design. With each CENTRA comes the support and guidance of a global network of project engineers who can ensure that your system design, commissioning and installation runs smoothly.

### The CENTRA solution

Products in our unrivalled CENTRA range provide the laboratory designer with a level of flexibility that is impossible to create with traditional central systems.

Of course, as with all ELGA solutions, ensuring lab water purity is a priority and was, therefore, a key element in the CENTRA design. CENTRA can incorporate a range of purification options that include: reverse osmosis (RO), UV photo-oxidation, sub-micron filtration, deionization, storage quality control and full system recirculation to match the water quality demands of the laboratory. Figures 2 and 3 illustrate the flexibility and economy of the CENTRA system.

### Adapting to changing laboratory needs

#### Figure 2: Today's lab water requirements.

One lab, located on the second floor, requires a distribution loop.

#### Figure 3: Tomorrow's lab water requirements.

An additional laboratory, on the third floor, requires a distribution loop. This can be easily connected to the CENTRA loop below (using a CENTRA-RDS), thus extending the distribution system. Alternatively, a new loop can be created using a standalone CENTRA-R 200. The CENTRA design can be further tailored to suit the activities in the new laboratory. In addition, the CENTRA systems can be interconnected to enable full redundancy, thereby ensuring that in the unlikely event of failure, water is still available.

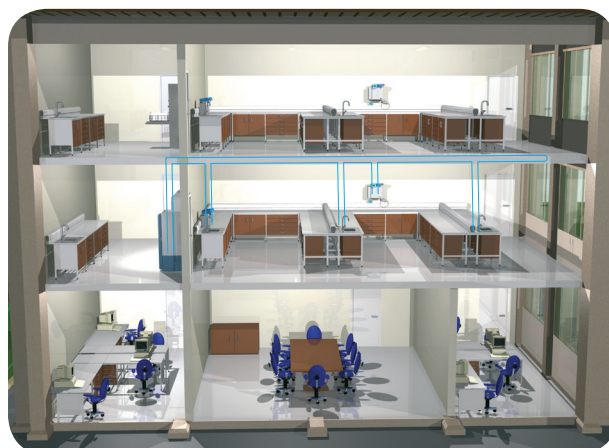

Figure 2

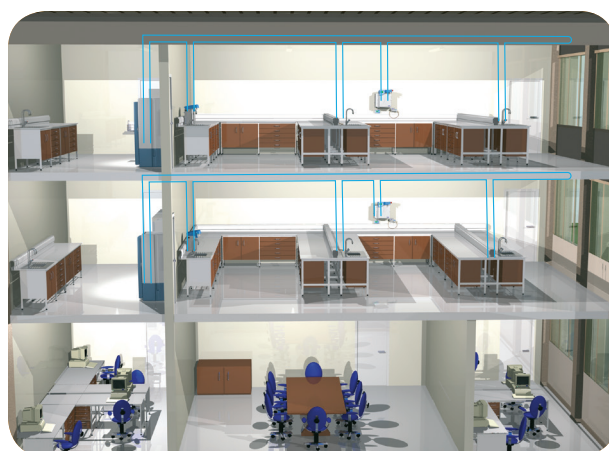
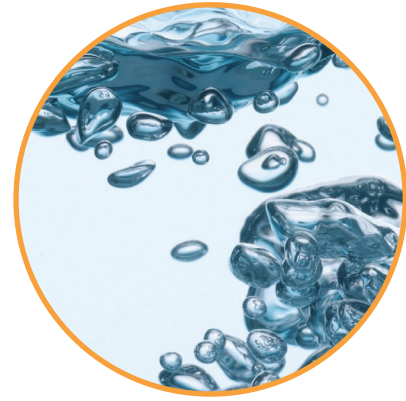

Figure 3



# Inside the CENTRA

The CENTRA range contains a wide selection of purification and distribution technologies to ensure the right fit for all the laboratories in your building

- 1 Reliable water quality**
  - Unique sanitization design for purification of RO membranes as well as the local distribution loop
  - Sanitization designed to run quickly and easily
  - User-defined, electronically protected sanitization reminders
- 2 Economic design**
  - Unique “wrap-around” reservoir
  - Easy-access doors and castors means system can be located under bench
- 3 Unique system operation protection**
  - Easy-to-use Building Management System
  - Automated alarms
  - Access to important control systems limited by ‘E-key’



CENTRA-R120

- 4 Energy saving, heat reducing distribution system**
  - Increase life of components
  - Reduces electrical costs
  - Reduces heat generation, inhibiting microbial growth

## Issues raised by traditional central laboratory water systems versus the CENTRA solution

### Purity

#### Traditional central systems

Water purity can be compromised as traditional central systems require reservoirs that are susceptible to bacterial contamination.

#### CENTRA solution

CENTRA systems are designed to provide water purity without compromise. The systems are placed close to high flow applications (e.g. large glass washers) and variable speed pumps can control the water flow in the loop to suit individual requirements, thereby eliminating the need for large storage volumes.

### Economy

Uneconomical use of space; a single centralized water purification and distribution system typically occupies a large area in a room that is separate from the laboratory (i.e. plant area or washing room).

Compact design allows CENTRA systems to be placed directly in or close to laboratories, thereby occupying less plant room space.

Higher costs – if only one or a few laboratories in a building require(s) a high flow rate for their applications, then all the laboratories (e.g. those requiring low flow rate or usage) must have a much larger and more complex purification and distribution design. This often results in higher costs as larger diameter pipework, increased pressure and flow rates are required.

CENTRA systems can be placed closer to the applications, saving costs by reducing lengths of pipework and excluding the need for larger diameters and minimizing pressures throughout the entire loop.

### Flexibility

Inflexible design; as pure water usage changes between laboratories, central systems must upgrade or downgrade throughout the entire building.

Modular design allows the optimum flow rate to be delivered separately to individual laboratories, i.e. requirements that range from high flow rate through to low usage can be met with the flexibility of the CENTRA system.

### Reliability

If the central system fails, then there is seldom a back-up; therefore, the entire suite of laboratories in a building will not have access to purified water “on tap”.

CENTRA systems can be interconnected to enable full redundancy, thereby ensuring that in the unlikely event of failure, water is still available.





# CENTRA RDS

## Distributing and recirculating pre-purified water centrally

The CENTRA-RDS stores, controls and distributes pre-purified water throughout a building (or a suite of laboratories) via a loop system. The system incorporates a 350 liter water storage reservoir and has advanced bacterial control as a result of a combination of UV photo-oxidation, an external purification cylinder and 0.2  $\mu\text{m}$  filter. The RDS is available as high flow variable speed model (HFV) that can deliver up to 30 liters/min to meet peak demand.

### CENTRA-RDS

#### Recirculating distribution system

- Integral 350 liter reservoir
- Loop flow rate of up to 18 liters/min
- Bacterial filter
- Recirculation pump for distribution of the pre-purified water around the loop system and back into the reservoir
- Access to a range of system monitoring and safety features via the central 'softkey' control panel
- UV photo-oxidation for enhanced microbial control
- 0.2  $\mu\text{m}$  filter to maintain water quality in the distribution loop
- Optional deionization cylinder may be positioned outside the CENTRA-RDS, but within the loop
- Composite vent filter helps maintain high water quality by preventing airborne gases and bacteria entering the reservoir
- Additional monitoring, including product water quality and consumable change reminder





## Process Flow CENTRA-RDS

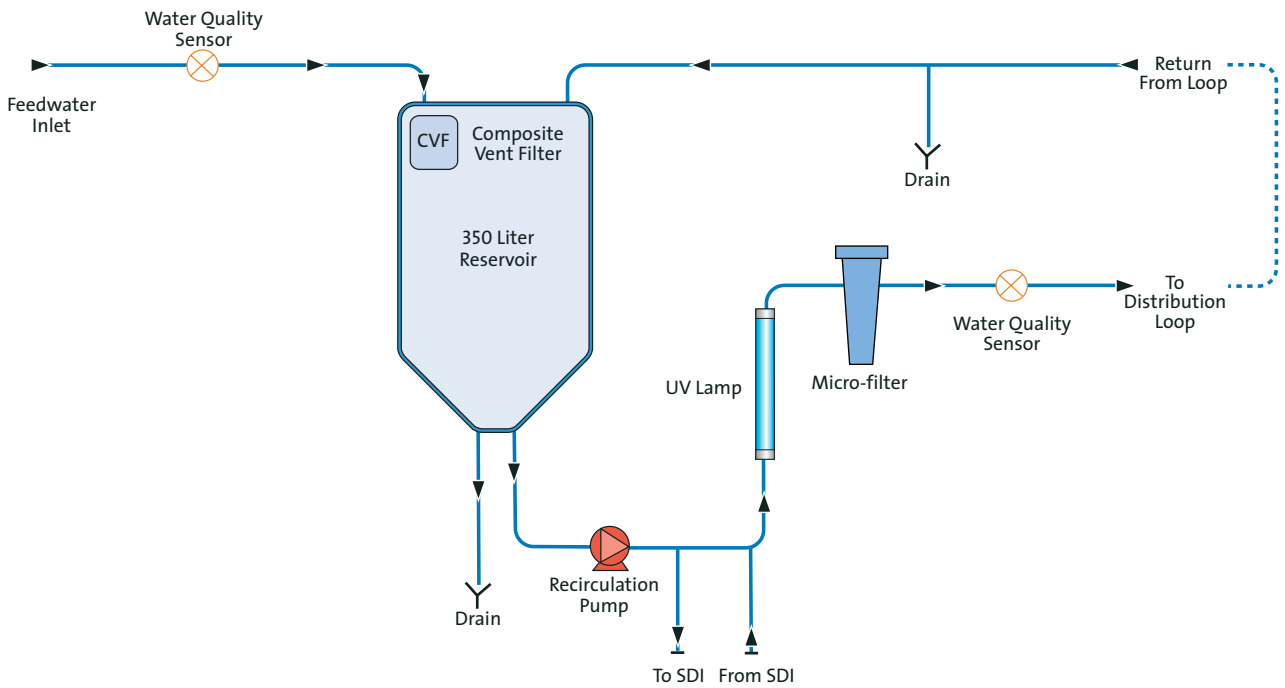



# CENTRA R 60, 120 and 200

## Centralized purification and distribution systems

The CENTRA-R 60, 120 and 200 offer complete water purification, storage, control and distribution systems featuring up to 200 liters/hr reverse osmosis modules and a 0.2 µm filter.

### CENTRA-R 60 and 120

The flexible solution for smaller distribution requirements.

- Optional cartridge-based deionization (simply plug and dispense)
- Extended deionization performance with optional CO<sub>2</sub> degassing
- UV photo-oxidation for enhanced bacterial control and TOC performance
- Optional 0.2µm filter for enhanced particle control
- Composite vent filter helps maintain high water purity by preventing airborne gases and bacteria entering the reservoir

- Flow rate of up to 10 liters/min
- Integral 50 liter reservoir
- Access to a wide range of system monitoring and safety features via the central “softkey” control panel
- Additional safety monitoring, including product water quality alarm and consumable change reminder

### CENTRA-R 200

The CENTRA-R 200 features the same technologies as the CENTRA-R 60 and 120 plus

- Optional deionization (or other purification media) may be positioned outside the CENTRA-R 200, but within the loop
- 0.2µm filter to maintain high water purity in the distribution loop
- Loop flow rate up to 18 liters/min with standard system or up to 30 liters/min with the high flow rate variable speed model
- Integral 350 liter reservoir

### Process Flow CENTRA-R 60/120

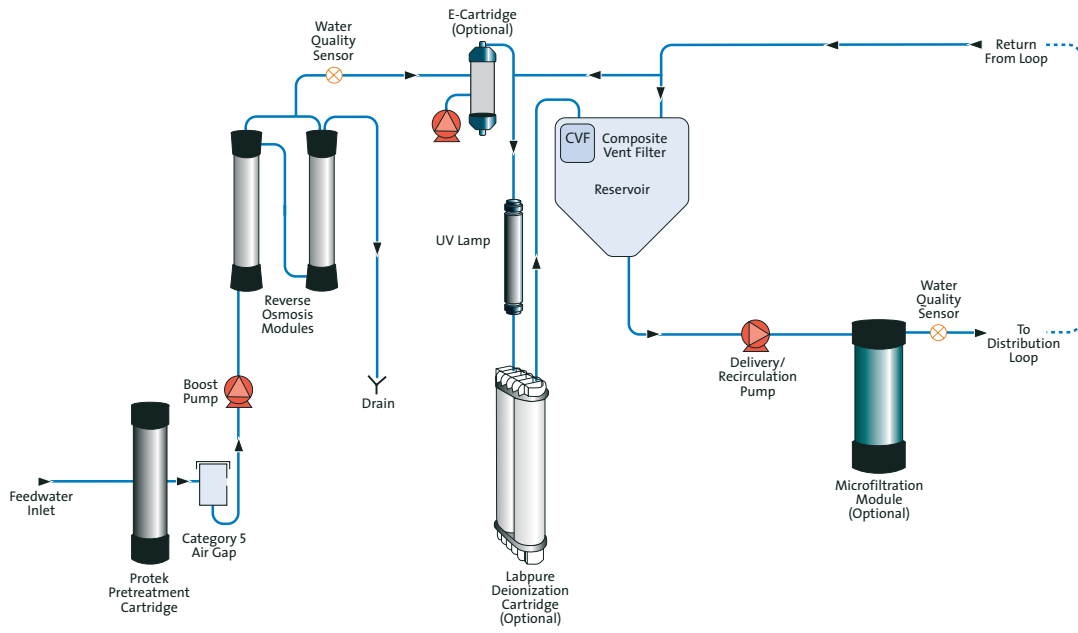

### Process Flow CENTRA-R 200

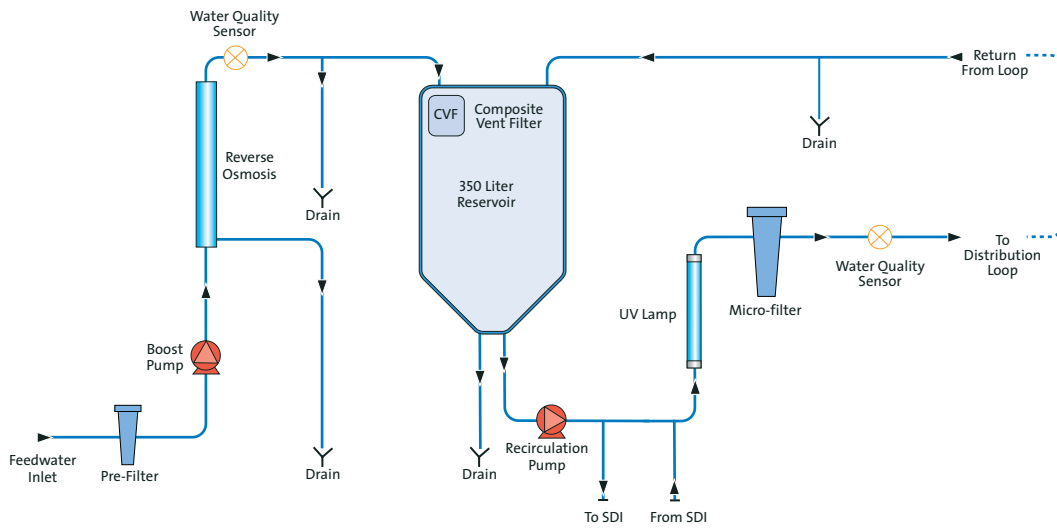

# The LabWater Specialists

ELGA is an integral part of Veolia, the global leader in optimized resource management. Veolia has a worldwide team of over 200,000 people and is renowned for its capabilities in providing water, waste and energy management solutions that contribute to the sustainable development of communities and industries.

The ELGA team focuses exclusively on water and its purification. It continually contributes to the unique technical and scientific applications and expertise developed for over 75 years. We are experienced in meeting the challenges that arise during the development, installation and servicing of single point-of-use water purification systems as well as large projects involving consultation with architects, consultants and clients.

## Commitment to global Sustainability

The ELGA products are designed to have the lowest possible impact on the environment at all stages: manufacture, in service and at end of life.

We can calculate the carbon value of all our products throughout their lifetime and we make this information available to our customers and partners.

Visit [www.elgalabwater.com/sc](http://www.elgalabwater.com/sc) for more details.

## Contact us:

ELGA offices and distributors are located in more than 60 countries and are fully trained in all ELGA systems.

To find your nearest ELGA representative, go to [www.elgalabwater.com](http://www.elgalabwater.com) and select your country for contact details.

### ELGA Global Operations Centre

tel: +44 (0) 203 567 7300

fax: +44 (0) 203 567 7205

[info@elgalabwater.com](mailto:info@elgalabwater.com)

[www.elgalabwater.com](http://www.elgalabwater.com)

### Your local ELGA representative



Scan this QR code with your smart mobile phone to find out more about ELGA and to contact your local representative.

ELGA is the global laboratory water brand name of Veolia. The information contained in this document is the property of VWS (UK) Ltd, trading as ELGA LabWater, and is supplied without liability for errors or omissions.

© VWS (UK) Ltd. 2015 – All rights reserved. ELGA®, PURELAB®, and CENTRA®, are registered trademarks of VWS (UK) Ltd.